

# EZGUIDE™

Guided Surgical Protocol





# EZGUIDE™

## Guided Surgical Protocol



### OVERVIEW

EZguide™ is an easy yet innovative approach to guided surgery.

Noris Medical developed this system to assist in “day to day” placement of “ routine” and pterygoid implant procedures. A simple to use surgical set allows the predictability of immediate loading with the efficiency of a short and error-proof workflow.

The EZguide™ surgical set allows the full capabilities of all guide types: From pilot drilling to fully guided implant loading, for bone, tissue, or teeth supported guides.

The EZguide™ surgical kit is suitable for tapered or cylindrical implants and is the only guided surgical set to include the ability to place pterygoid implants - Fully guided in the same set.

Supported by top-notch implant planning and surgical guide software, the EZplan™ software permits modular capabilities for seamless communication between the clinician and the laboratory for implants placement and design for surgical guides. The EZplan™ is used for all of Noris Medical’s Internal Hex implants and can be used in-house or outsourced by the Noris Digital Team.

## CHALLENGES ADDRESSED

With the broad portfolio of implants Noris Medical offers, it is crucial to have one guided surgical instrumentation set that is able to support it all.

The guided surgical set will control the location, orientation, and the final position of the implant. Maximum precision and accuracy is paramount in order to fabricate and deliver a prosthesis immediately on the day of surgery.

It is optimal to achieve the above with the shortest, most efficient workflow and minimal error. A synergy of software instruments is needed to eliminate human error prior to and during surgery as well as have the ability to design the precise prosthetics for immediate load. All using a digital workflow.

Simple drilling protocol is a challenging mission to achieve, especially when it comes to pterygoids and very long implants for tilted implants approach. The EZguide™ guided surgical set, offers simple and spoon-less drills and step-drills, enables the shortest drilling steps to achieve a suitable tapered osteotomy from 6mm to 18mm implant length, and from 3.3mm to 5mm implant diameter.

In order to reduce human errors to a minimum, it is essential to keep the clinician's attention at the surgical site throughout the entire procedure. The printed drilling protocol on the EZguide™ guided surgical set tray, along with color-coded sleeves inside the guide, enables the dentist an efficient and Machined operation, obviating the need to jump back and forth from the printed protocol to the surgical site.

## BENEFITS

- Universal guided surgical set for Internal Hex implants
- The first and only fully guided set to include pterygoid solution
- Unparalleled precision for 6-18mm implants
- Increased safety and minimized human errors due to color coding
- An easier procedure for both for the patient and the surgeon
- Increased confidence for both the clinician and patient
- Immediate Loading of prefabricated temporary bridge, due to expected precision and implant's depth/orientation control mounted through the guide





# CLASSIC SERIES

Conical Platform

\*Optional

	Soft Bone				Dense Bone	10 mm
	Tissue Punch	Bone Prep	Starter Drill	Pilot Drill	Surgical Drill	
<b>3.25</b> L10						
Drill Speed (RPM)	25	500	400-600	400-600	200-400	
Ø D (mm)	4.4	4	1.5-2	2	2.8	
L (mm)			6	10	6	

\*Optional

	Soft Bone				Dense Bone		10 mm
	Tissue Punch	Bone Prep	Starter Drill	Pilot Drill	Pilot Drill	Surgical Drill	
<b>3.25</b> L11.5							
Drill Speed (RPM)	25	500	400-600	400-600	400-600	200-400	
Ø D (mm)	4.4	4	1.5-2	2	2	2.8	
L (mm)			6	8	11.5	6	

\*Optional

	Soft Bone				Dense Bone		10 mm
	Tissue Punch	Bone Prep	Starter Drill	Pilot Drill	Pilot Drill	Surgical Drill	
<b>3.25</b> L13							
Drill Speed (RPM)	25	500	400-600	400-600	400-600	200-400	
Ø D (mm)	4.4	4	1.5-2	2	2	2.8	
L (mm)			6	10	13	8	

# CLASSIC SERIES

## Conical Platform

\*Optional

	Soft Bone					Dense Bone
	Tissue Punch	Bone Prep	Starter Drill	Pilot Drill	Pilot Drill	Surgical Drill
<b>3.25</b> L16						
Drill Speed (RPM)	25	500	400-600	400-600	400-600	200-400
Ø D (mm)	4.4	4	1.5-2	2	2	2.8
L (mm)			6	10	16	10

\*Optional

	Soft Bone				Dense Bone
	Tissue Punch	Bone Prep	Starter Drill	Pilot Drill	Surgical Drill
<b>Ø3.5</b> L8					
Drill Speed (RPM)	25	500	400-600	400-600	200-400
Ø D (mm)	4.4	4	1.5-2	2	2.8
L (mm)			6	8	6

\*Optional

	Soft Bone				Dense Bone
	Tissue Punch	Bone Prep	Starter Drill	Pilot Drill	Surgical Drill
<b>Ø3.5</b> L10					
Drill Speed (RPM)	25	500	400-600	400-600	200-400
Ø D (mm)	4.4	4	1.5-2	2	2.8
L (mm)			6	10	6





# CLASSIC SERIES

Conical Platform

\*Optional

	Soft Bone					Dense Bone	10 mm
	Tissue Punch	Bone Prep	Starter Drill	Pilot Drill	Pilot Drill	Surgical Drill	
<b>Ø3.5</b> <b>L11.5</b>							
Drill Speed (RPM)	25	500	400-600	400-600	400-600	200-400	
Ø D (mm)	4.4	4	1.5-2	2	2	2.8	
L (mm)			6	8	11.5	8	

\*Optional

	Soft Bone					Dense Bone	10 mm
	Tissue Punch	Bone Prep	Starter Drill	Pilot Drill	Pilot Drill	Surgical Drill	
<b>Ø3.5</b> <b>L13</b>							
Drill Speed (RPM)	25	500	400-600	400-600	400-600	200-400	
Ø D (mm)	4.4	4	1.5-2	2	2	2.8	
L (mm)			6	10	13	8	





\*Optional

	Soft Bone					Dense Bone	10 mm
	Tissue Punch	Bone Prep	Starter Drill	Pilot Drill	Pilot Drill	Surgical Drill	
<b>Ø3.5</b> <b>L16</b>							
Drill Speed (RPM)	25	500	400-600	400-600	400-600	200-400	
Ø D (mm)	4.4	4	1.5-2	2	2	2.8	
L (mm)			6	10	16	10	





# CLASSIC SERIES

Internal Hex Platform





\*Optional

	Soft Bone				Dense Bone
	Tissue Punch	Bone Prep	Starter Drill	Pilot Drill	Surgical Drill
<b>Ø3.3</b> <b>L8</b>					
Drill Speed (RPM)	25	500	400-600	400-600	200-400
Ø D (mm)	4.4	4	1.5-2	2	2.8
L (mm)			6	8	8

\*Optional

	Soft Bone				Dense Bone
	Tissue Punch	Bone Prep	Starter Drill	Pilot Drill	Surgical Drill
<b>Ø3.3</b> <b>L10</b>					
Drill Speed (RPM)	25	500	400-600	400-600	200-400
Ø D (mm)	4.4	4	1.5-2	2	2.8
L (mm)			6	10	10

\*Optional

	Soft Bone				Dense Bone
	Tissue Punch	Bone Prep	Starter Drill	Pilot Drill	Surgical Drill
<b>Ø3.3</b> <b>L11.5</b>					
Drill Speed (RPM)	25	500	400-600	400-600	200-400
Ø D (mm)	4.4	4	1.5-2	2	2.8
L (mm)			6	8	11.5





# CLASSIC SERIES

Internal Hex Platform

\*Optional

	Soft Bone					Dense Bone	10 mm
	Tissue Punch	Bone Prep	Starter Drill	Pilot Drill	Pilot Drill	Surgical Drill	
<b>Ø3.3</b> <b>L13</b>							
Drill Speed (RPM)	25	500	400-600	400-600	400-600	200-400	
Ø D (mm)	4.4	4	1.5-2	2	2	2.8	
L (mm)			6	10	13		







\*Optional

	Soft Bone					Dense Bone	10 mm
	Tissue Punch	Bone Prep	Starter Drill	Pilot Drill	Pilot Drill	Surgical Drill	
<b>Ø3.3</b> <b>L16</b>							
Drill Speed (RPM)	25	500	400-600	400-600	400-600	200-400	
Ø D (mm)	4.4	4	1.5-2	2	2	2.8	
L (mm)			6	10	16		







# CLASSIC SERIES

Internal Hex Platform / Conical Platform







\*Optional

	Soft Bone					Dense Bone	*Optional
	Tissue Punch	Bone Prep	Starter Drill	Pilot Drill	Pilot Drill	Surgical Drill	
<b>Ø3.75</b> <b>L6</b>							
Drill Speed (RPM)	25	500	400-600	400-600	200-400	200-400	
Ø D (mm)	4.4	4	1.5-2	2	2.8	2.8-3.2	
L (mm)			6	6		6	

\*Optional

	Soft Bone					Dense Bone	*Optional
	Tissue Punch	Bone Prep	Starter Drill	Pilot Drill	Pilot Drill	Surgical Drill	
<b>Ø3.75</b> <b>L8</b>							
Drill Speed (RPM)	25	500	400-600	400-600	200-400	200-400	
Ø D (mm)	4.4	4	1.5-2	2	2.8	2.8-3.2	
L (mm)			6	8		8	

\*Optional

	Soft Bone					Dense Bone	*Optional
	Tissue Punch	Bone Prep	Starter Drill	Pilot Drill	Pilot Drill	Surgical Drill	
<b>Ø3.75</b> <b>L10</b>							
Drill Speed (RPM)	25	500	400-600	400-600	200-400	200-400	
Ø D (mm)	4.4	4.0	1.5-2	2	2.8	2.8-3.2	
L (mm)			6	10		10	





# CLASSIC SERIES

Internal Hex Platform / Conical Platform

\*Optional

	Soft Bone						Dense Bone
	Tissue Punch	Bone Prep	Starter Drill	Pilot Drill	Pilot Drill	Surgical Drill	Surgical Drill
<b>Ø3.75</b> <b>L11.5</b>							
Drill Speed (RPM)	25	500	400-600	400-600	400-600	200-400	200-400
Ø D (mm)	4.4	4	1.5-2	2	2	2.8	2.8-3.2
L (mm)			6	8		11.5	

\*Optional

	Soft Bone						Dense Bone
	Tissue Punch	Bone Prep	Starter Drill	Pilot Drill	Pilot Drill	Surgical Drill	Surgical Drill
<b>Ø3.75</b> <b>L13</b>							
Drill Speed (RPM)	25	500	400-600	400-600	400-600	200-400	200-400
Ø D (mm)	4.4	4	1.5-2	2	2	2.8	2.8-3.2
L (mm)			6	10		13	

\*Optional

	Soft Bone						Dense Bone
	Tissue Punch	Bone Prep	Starter Drill	Pilot Drill	Pilot Drill	Surgical Drill	Surgical Drill
<b>Ø3.75</b> <b>L16</b>							
Drill Speed (RPM)	25	500	400-600	400-600	400-600	200-400	200-400
Ø D (mm)	4.4	4	1.5-2	2	2	2.8	2.8-3.2
L (mm)			6	10		16	

# CLASSIC SERIES

Internal Hex Platform / Conical Platform

\*Optional

	Soft Bone						Dense Bone	10 mm
	Tissue Punch	Bone Prep	Starter Drill	Pilot Drill	Pilot Drill	Surgical Drill	Surgical Drill	
<b>Ø4.2</b> <b>L6</b>								
Drill Speed (RPM)	25	500	400-600	400-600	200-400	200-400	200-400	
Ø D (mm)	5	5	1.5-2	2	2.8	2.8-3.2	3.2-3.65	
L (mm)			6	6		6		

\*Optional

	Soft Bone						Dense Bone	10 mm
	Tissue Punch	Bone Prep	Starter Drill	Pilot Drill	Pilot Drill	Surgical Drill	Surgical Drill	
<b>Ø4.2</b> <b>L8</b>								
Drill Speed (RPM)	25	500	400-600	400-600	200-400	200-400	200-400	
Ø D (mm)	5	5	1.5-2	2	2.8	2.8-3.2	3.2-3.65	
L (mm)			6	8		8		

\*Optional

	Soft Bone						Dense Bone	10 mm
	Tissue Punch	Bone Prep	Starter Drill	Pilot Drill	Pilot Drill	Surgical Drill	Surgical Drill	
<b>Ø4.2</b> <b>L10</b>								
Drill Speed (RPM)	25	500	400-600	400-600	200-400	200-400	200-400	
Ø D (mm)	5	5	1.5-2	2	2.8	2.8-3.2	3.2-3.65	
L (mm)			6	10		10		





# CLASSIC SERIES

Internal Hex Platform / Conical Platform

\*Optional

	Soft Bone							Dense Bone
	Tissue Punch	Bone Prep	Starter Drill	Pilot Drill	Pilot Drill	Surgical Drill	Surgical Drill	Surgical Drill
<b>Ø4.2</b> <b>L11.5</b>								
Drill Speed (RPM)	25	500	400-600	400-600	400-600	200-400	200-400	200-400
Ø D (mm)	5	5	1.5-2	2	2	2.8	2.8-3.2	3.2-3.65
L (mm)			6	8		11.5		

\*Optional

	Soft Bone							Dense Bone
	Tissue Punch	Bone Prep	Starter Drill	Pilot Drill	Pilot Drill	Surgical Drill	Surgical Drill	Surgical Drill
<b>Ø4.2</b> <b>L13</b>								
Drill Speed (RPM)	25	500	400-600	400-600	400-600	200-400	200-400	200-400
Ø D (mm)	5	5	1.5-2	2	2	2.8	2.8-3.2	3.2-3.65
L (mm)			6	10		13		

\*Optional

	Soft Bone							Dense Bone
	Tissue Punch	Bone Prep	Starter Drill	Pilot Drill	Pilot Drill	Surgical Drill	Surgical Drill	Surgical Drill
<b>Ø4.2</b> <b>L16</b>								
Drill Speed (RPM)	25	500	400-600	400-600	400-600	200-400	200-400	200-400
Ø D (mm)	5	5	1.5-2	2	2	2.8	2.8-3.2	3.2-3.65
L (mm)			6	10		16		

# CLASSIC SERIES

Internal Hex Platform / Conical Platform

\*Optional

Ø5.0 L6	Soft Bone							Dense Bone	10 mm
	Tissue Punch	Bone Prep	Starter Drill	Pilot Drill	Pilot Drill	Surgical Drill	Surgical Drill	Surgical Drill	
Drill Speed (RPM)	25	500	400-600	400-600	200-400	200-400	200-400	200-400	
Ø D (mm)	5	5	1.5-2	2	2.8	2.8-3.2	3.2-3.65	3.65-4.2	
L (mm)			6	6			6		

\*Optional

Ø5.0 L8	Soft Bone							Dense Bone	10 mm
	Tissue Punch	Bone Prep	Starter Drill	Pilot Drill	Pilot Drill	Surgical Drill	Surgical Drill	Surgical Drill	
Drill Speed (RPM)	25	500	400-600	400-600	200-400	200-400	200-400	200-400	
Ø D (mm)	5	5	1.5-2	2	2.8	2.8-3.2	3.2-3.65	3.65-4.2	
L (mm)			6	8			8		

\*Optional

Ø5.0 L10	Soft Bone							Dense Bone	10 mm
	Tissue Punch	Bone Prep	Starter Drill	Pilot Drill	Pilot Drill	Surgical Drill	Surgical Drill	Surgical Drill	
Drill Speed (RPM)	25	500	400-600	400-600	200-400	200-400	200-400	200-400	
Ø D (mm)	5	5	1.5-2	2	2.8	2.8-3.2	3.2-3.65	3.65-4.2	
L (mm)			6	10			10		





# CLASSIC SERIES

Internal Hex Platform / Conical Platform







	Soft Bone								Dense Bone	*Optional
	Tissue Punch	Bone Prep	Starter Drill	Pilot Drill	Pilot Drill	Surgical Drill	Surgical Drill	Surgical Drill	Surgical Drill	
<b>Ø5.0</b> L11.5										
Drill Speed (RPM)	25	500	400-600	400-600	400-600	200-400	200-400	200-400	200-400	
Ø D (mm)	5	5	1.5-2	2	2	2.8	2.8-3.2	3.2-3.65	3.65-4.2	
L (mm)			6	8		11.5				

	Soft Bone								Dense Bone	*Optional
	Tissue Punch	Bone Prep	Starter Drill	Pilot Drill	Pilot Drill	Surgical Drill	Surgical Drill	Surgical Drill	Surgical Drill	
<b>Ø5.0</b> L13										
Drill Speed (RPM)	25	500	400-600	400-600	400-600	200-400	200-400	200-400	200-400	
Ø D (mm)	5	5	1.5-2	2	2	2.8	2.8-3.2	3.2-3.65	3.65-4.2	
L (mm)			6	10		13				







	Soft Bone								Dense Bone	*Optional
	Tissue Punch	Bone Prep	Starter Drill	Pilot Drill	Pilot Drill	Surgical Drill	Surgical Drill	Surgical Drill	Surgical Drill	
<b>Ø5.0</b> L16										
Drill Speed (RPM)	25	500	400-600	400-600	400-600	200-400	200-400	200-400	200-400	
Ø D (mm)	5	5	1.5-2	2	2	2.8	2.8-3.2	3.2-3.65	3.65-4.2	
L (mm)			6	10		16				

# ONE-PIECE SERIES

\*Optional

	Soft Bone				Dense Bone	*Optional
	Tissue Punch	Bone Prep	Starter Drill	Pilot Drill	Surgical Drill	
<b>Ø3</b> L8						
Drill Speed (RPM)	25	500	400-600	400-600	200-400	
Ø D (mm)	4.4	4	1.5-2	2	2.8	
L (mm)			6	8	8	

\*Optional

	Soft Bone				Dense Bone	*Optional
	Tissue Punch	Bone Prep	Starter Drill	Pilot Drill	Surgical Drill	
<b>Ø3</b> L10						
Drill Speed (RPM)	25	500	400-600	400-600	200-400	
Ø D (mm)	4.4	4	1.5-2	2	2.8	
L (mm)			6	10	10	





# ONE-PIECE SERIES

\*Optional

	Soft Bone					Dense Bone
	Tissue Punch	Bone Prep	Starter Drill	Pilot Drill	Pilot Drill	Surgical Drill
<b>Ø3</b> L11.5						
Drill Speed (RPM)	25	500	400-600	400-600	400-600	200-400
Ø D (mm)	4.4	4	1.5-2	2	2	2.8
L (mm)			6	8	11.5	

\*Optional





	Soft Bone					Dense Bone
	Tissue Punch	Bone Prep	Starter Drill	Pilot Drill	Pilot Drill	Surgical Drill
<b>Ø3</b> L13						
Drill Speed (RPM)	25	500	400-600	400-600	400-600	200-400
Ø D (mm)	4.4	4	1.5-2	2	2	2.8
L (mm)			6	10	13	

\*Optional





	Soft Bone					Dense Bone
	Tissue Punch	Bone Prep	Starter Drill	Pilot Drill	Pilot Drill	Surgical Drill
<b>Ø3</b> L16						
Drill Speed (RPM)	25	500	400-600	400-600	400-600	200-400
Ø D (mm)	4.4	4	1.5-2	2	2	2.8
L (mm)			6	10	16	

# ONE-PIECE SERIES





\*Optional

	Soft Bone				Dense Bone
	Tissue Punch	Bone Prep	Starter Drill	Pilot Drill	Surgical Drill
<b>Ø3.3</b> <b>L6</b>					
Drill Speed (RPM)	25	500	400-600	400-600	200-400
Ø D (mm)	4.4	4	1.5-2	2	2.8
L (mm)			6	6	6

\*Optional

	Soft Bone				Dense Bone
	Tissue Punch	Bone Prep	Starter Drill	Pilot Drill	Surgical Drill
<b>Ø3.3</b> <b>L8</b>					
Drill Speed (RPM)	25	500	400-600	400-600	200-400
Ø D (mm)	4.4	4	1.5-2	2	2.8
L (mm)			6	8	8

\*Optional

	Soft Bone				Dense Bone
	Tissue Punch	Bone Prep	Starter Drill	Pilot Drill	Surgical Drill
<b>Ø3.3</b> <b>L10</b>					
Drill Speed (RPM)	25	500	400-600	400-600	200-400
Ø D (mm)	4.4	4	1.5-2	2	2.8
L (mm)			6	10	10





# ONE-PIECE SERIES

\*Optional

	Soft Bone					Dense Bone
	Tissue Punch	Bone Prep	Starter Drill	Pilot Drill	Pilot Drill	Surgical Drill
<b>Ø3.3</b> <b>L11.5</b>						
Drill Speed (RPM)	25	500	400-600	400-600	400-600	200-400
Ø D (mm)	4.4	4	1.5-2	2	2	2.8
L (mm)			6	8	11.5	

\*Optional

	Soft Bone					Dense Bone
	Tissue Punch	Bone Prep	Starter Drill	Pilot Drill	Pilot Drill	Surgical Drill
<b>Ø3.3</b> <b>L13</b>						
Drill Speed (RPM)	25	500	400-600	400-600	400-600	200-400
Ø D (mm)	4.4	4	1.5-2	2	2	2.8
L (mm)			6	10	13	

\*Optional

	Soft Bone					Dense Bone
	Tissue Punch	Bone Prep	Starter Drill	Pilot Drill	Pilot Drill	Surgical Drill
<b>Ø3.3</b> <b>L16</b>						
Drill Speed (RPM)	25	500	400-600	400-600	400-600	200-400
Ø D (mm)	4.4	4	1.5-2	2	2	2.8
L (mm)			6	10	16	

# CLASSIC SERIES

Internal Hex Platform / Conical Platform

**Ø4.2**  
**L18**

Drill Speed (RPM)		200-400
Ø D (mm)		2.8
L (mm)		18

**Ø4.2**  
**L20**

Drill Speed (RPM)		200-400
Ø D (mm)		2.8
L (mm)		20

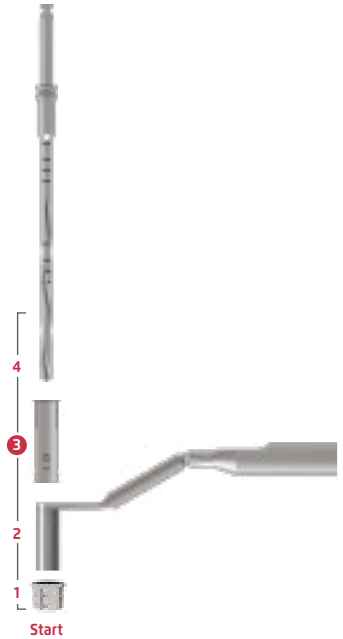



# CLASSIC SERIES

Internal Hex Platform / Conical Platform

	Tissue Punch	Bone Prep	
<b>Ø4.2</b> <b>L22</b>			
Drill Speed (RPM)		200-400	
Ø D (mm)		2.8	
L (mm)		22	

	Tissue Punch	Bone Prep	
<b>Ø4.2</b> <b>L25</b>			
L (mm)		25	

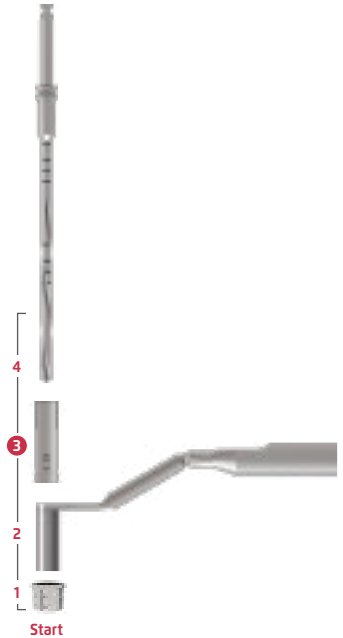



# EXCELLENCE

in execution

Trusted by Experts. Every Case. Every Day.

LBL058 Rev.2026-1



[www.norismedical.com](http://www.norismedical.com)

